

---

# GEOSOFT 2.0

 *User Manual*



## CONTENTS

<b>INTRODUCTION .....</b>	<b>6</b>
<b>MENU SELECTIONS .....</b>	<b>7</b>
FILE MENU .....	7
<i>New .....</i>	7
<i>Open.....</i>	7
<i>Save .....</i>	7
<i>Save As .....</i>	7
<i>Import Geosoft 1 Projects.....</i>	7
<i>Export.....</i>	7
<i>Print.....</i>	7
<i>Exit .....</i>	7
EDIT MENU .....	8
<i>Add Cluster.....</i>	8
<i>Duplicate Cluster .....</i>	8
<i>Delete Cluster.....</i>	8
<i>Rename Cluster.....</i>	8
<i>Edit Cluster Positions .....</i>	8
EDIT VENUE .....	9
SPECTRUM (NEW).....	9
<i>Show / Hide Spectrum.....</i>	9
<i>New Point .....</i>	10
<i>Edit Point.....</i>	10
<i>Delete Point.....</i>	10
OPTIONS MENU .....	10
<i>Meter / Feet Units.....</i>	10
<i>Edit air absorption.....</i>	11
<i>3D Mode / 2D Mode .....</i>	11
HELP MENU .....	11
<i>Help.....</i>	11
<i>Structural Analysis.....</i>	11
<i>User Manuals .....</i>	11
<i>About Geosoft.....</i>	11



<b>ENTERING &amp; EDITING VENUE.....</b>	<b>12</b>
EDIT VENUE PLANES.....	12
<i>Audience</i> .....	13
<i>Annotation</i> .....	13
<i>Vertex 1 to 4</i> .....	13
MENU .....	13
<i>Edit Venue (3D Mode)</i> .....	13
<i>Add plane</i> .....	14
<i>Duplicate plane</i> .....	14
<i>Delete Plane</i> .....	14
<i>Invert Plane</i> .....	14
<i>Set Audience for all</i> .....	14
<i>Open Venue File</i> .....	14
<i>Importing Audience planes from Ease 4</i> .....	14
<i>Save Venue File</i> .....	14
<i>Edit Venue (2D Mode)</i> .....	15
<b>PROJECT WINDOW .....</b>	<b>16</b>
<i>Project</i> .....	16
<i>Company</i> .....	16
<i>Author</i> .....	16
<i>Date</i> .....	16
<i>Text Window</i> .....	16
<b>GEO CLUSTER ACOUSTIC WINDOW .....</b>	<b>17</b>
<i>Cluster Type</i> .....	17
<i>Speaker Quantity</i> .....	17
<i>Insert / Remove</i> .....	17
<i>Move Towards Bumper / Move Away Bumper</i> .....	17
<i>Rig Angles Tab</i> .....	18
<i>Step</i> .....	18
<i>CDD</i> .....	19
<i>Cluster Position</i> .....	19
<i>Pressure Plot and Frequency Response display</i> .....	19
<i>Simulation conditions</i> .....	20



<b>GEO S8 CLUSTER MECHANICAL WINDOW</b> .....	<b>21</b>
CONFIGURATION SETTINGS .....	21
<i>Rigging Mode</i> .....	21
<i>Wind Beaufort 8</i> .....	21
<i>Cluster Secured</i> .....	21
CLUSTER DIMENSIONS AND WEIGHT .....	22
MECHANICAL FORCES.....	23
ANGLE SEQUENCE.....	23
WORKING LOAD – SAFETY FACTOR – LIFTING FACTOR .....	24
<i>Percentage of Allowed Working Load</i> .....	24
<i>Safety Factor for 100% of Allowed Working Load</i> .....	24
<i>Lifting Factor</i> .....	24
CAUTION – WARNING MESSAGES .....	24
<i>Permanently displayed messages</i> .....	24
<i>Conditional messages</i> .....	24
<i>Cluster Drawings</i> .....	25
<b>GEO S12 CLUSTER MECHANICAL WINDOW</b> .....	<b>26</b>
CONFIGURATION SETTINGS .....	26
<i>Rigging Mode</i> .....	26
<i>Rigging point position</i> .....	26
<i>Rear rigging point</i> .....	26
<i>Front rigging point</i> .....	26
<i>Wind Beaufort 8</i> .....	26
<i>Cluster Secured</i> .....	26
CLUSTER DIMENSIONS AND WEIGHT .....	27
MECHANICAL FORCES.....	28
ANGLE SEQUENCE.....	28
WORKING LOAD – SAFETY FACTOR – LIFTING FACTOR .....	28
CAUTION – WARNING MESSAGES .....	28
<i>Permanently displayed messages</i> .....	28
<i>Conditional messages</i> .....	28
<i>Cluster Drawings</i> .....	29



<b>GEO D CLUSTER MECHANICAL WINDOW .....</b>	<b>30</b>
CONFIGURATION SETTINGS .....	30
<i>Rigging top (case dependent, selectable) .....</i>	<i>30</i>
<i>Rigging bottom (case dependent, automatic) .....</i>	<i>30</i>
<i>Chain lever hoist (selectable) .....</i>	<i>30</i>
<i>Wind Beaufort 8.....</i>	<i>30</i>
<i>Cluster Secured.....</i>	<i>30</i>
CLUSTER DIMENSIONS AND WEIGHT (2 RIGGING POINTS) .....	31
MECHANICAL FORCES.....	32
CLUSTER DIMENSIONS AND WEIGHT (1 RIGGING POINT) .....	33
MECHANICAL FORCES.....	34
ANGLE SEQUENCE.....	35
WORKING LOAD – SAFETY FACTOR – LIFTING FACTOR .....	35
<i>GeoD cluster - Percentage of Allowed Working Load.....</i>	<i>35</i>
<i>GeoD cluster - Safety Factor for 100% of Allowed Working Load .....</i>	<i>35</i>
CAUTION – WARNING MESSAGES .....	36
<i>Permanently displayed messages .....</i>	<i>36</i>
<i>Conditional messages .....</i>	<i>36</i>
<i>Cluster Drawings .....</i>	<i>36</i>
<b>GEO T CLUSTER MECHANICAL WINDOW.....</b>	<b>37</b>
CONFIGURATION SETTINGS .....	37
<i>Rigging Mode .....</i>	<i>37</i>
<i>Wind Beaufort 8.....</i>	<i>37</i>
<i>Cluster Secured.....</i>	<i>37</i>
CLUSTER DIMENSIONS AND WEIGHT .....	38
MECHANICAL FORCES.....	39
ANGLE SEQUENCE.....	40
WORKING LOAD – SAFETY FACTOR – LIFTING FACTOR .....	40
<i>GeoT cluster - Percentage of Allowed Working Load.....</i>	<i>40</i>
<i>GeoT cluster - Safety Factor for 100% of Allowed Working Load.....</i>	<i>40</i>
<i>CD18 cluster - Percentage of Allowed Working Load.....</i>	<i>40</i>
<i>CD18 cluster - Safety Factor for 100% of Allowed Working Load.....</i>	<i>40</i>
CAUTION – WARNING MESSAGES .....	41
<i>Permanently displayed messages .....</i>	<i>41</i>
<i>Conditional messages .....</i>	<i>41</i>
<i>Cluster Drawings .....</i>	<i>41</i>



## INTRODUCTION

GEOSoft2 software is a R&D simulation tool derived application. It processes measured speaker data with complex mathematical algorithms to assist the user in designing vertical GEO Tangent Arrays that provide even SPL throughout the depth of the audience. Due to the complexity of the interaction of multiple cabinets, it is simply not possible to reliably design curved vertical arrays without using the processing power of a computer to predict the optimum array structure for a given audience geometry. The design logic is far more complex than looking at a section drawing of the venue, measuring the overall angle needed to cover the audience from the cluster location, and dividing by 5degrees to determine the required amount number of S805 cabinets.

GEOSoft2 is an easy to use tool that allows to shape the energy leaving the cluster to fit the audience. It predicts pressure levels radiated from the system to ensure enough cabinets are provided for the application, as well as mechanical constraints for safe flown systems.

In addition, it provides mechanical information for all clusters in agreement with Structural Analysis Reports (available in the Help section): dimensions, weight, gravity center position, forces, moments, working load and safety factor.

Geo S8, Geo D and Geo T Structural Analysis Reports have been validated by German Certification Organization RWTUV systems GmbH.

Geo S12 Structural Analysis Report is currently being examined by German Certification Organization RWTUV systems GmbH.

Please check the NEXO Web Site periodically ([www.nexo-sa.com](http://www.nexo-sa.com)) for upgrades.

Any question or bug report please contact [geosoft@nexo.fr](mailto:geosoft@nexo.fr)

## MENU SELECTIONS

### File Menu



New

Opens a blank file (GeoS Cluster, no venue information)

Open

Opens previously saved configuration *filename.nexo*

Save

Saves the configuration as previously saved *filename.nexo*

Save As

Saves the configuration as *filename.nexo* (approximate size : 50 KB).

Import Geosoft 1 Projects

Imports Geosoft 1 .MAT file (extends Geosoft 2D lines to 3D 2 meters width planes)

Export

Exports currently displayed window in a JPEG format (approximate size: 100 kB).

Print

Opens Print Dialog Window and Preview

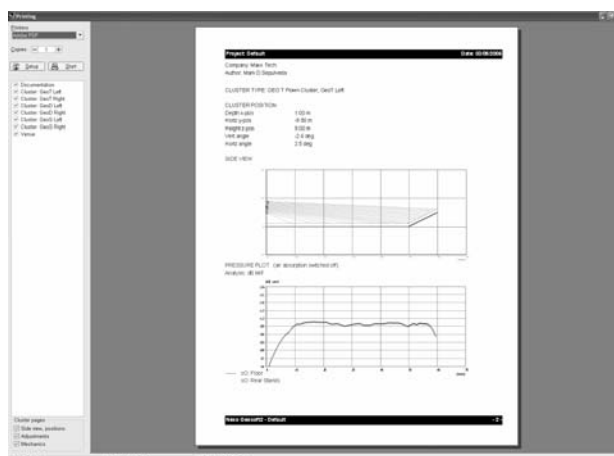

Exit

Ends the Geosoft 2 session.

## Edit Menu

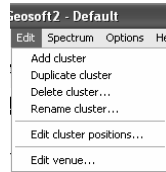

Add Cluster

Adds Cluster (New Cluster Window)

Duplicate Cluster

Opens Offset Position Window, which allows x or y cluster mirroring and offset cluster duplication

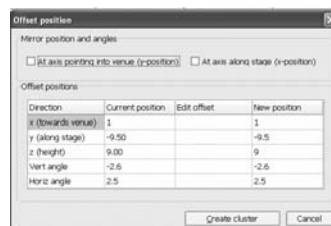

Delete Cluster

Deletes Selected Cluster (Deletes selected Cluster Tab)

Rename Cluster

Renames Cluster

Edit Cluster Positions

Opens the Edit Cluster Window:

Cluster	Depth, x-pos (Meter)	Horiz, y-pos (Meter)	Height, z-pos (Meter)	Horiz angle (degree)	Vert angle (degree)	Show horiz coverage
GeoT Left	1.00	-9.50	9.00	2.5	-2.6	<input type="checkbox"/>
GeoT Right	1	9.5	9	-2.5	-2.6	<input type="checkbox"/>
GeoD Left	20	-9.5	9	1.5	-1	<input type="checkbox"/>
GeoD Right	20	9.5	9	-1.5	-1	<input type="checkbox"/>
GeoS Left	-3.50	-12.00	9.00	-45	-11	<input type="checkbox"/>
GeoS Right	-3.50	12.00	9.00	45	-11	<input type="checkbox"/>

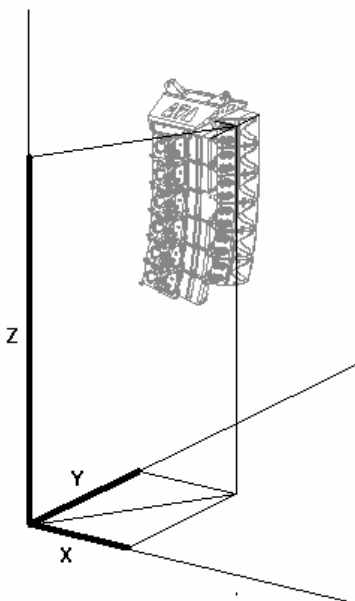

### Depth, x-pos

when cluster flown, distance between top of first cabinet and venue geometry reference point 0 along X axis;

when cluster stacked, distance between bottom of first cabinet and venue reference point 0 along X axis;

### Horiz, y-pos

when cluster flown, distance between center of first cabinet and venue geometry reference point 0 along Y axis;

when cluster stacked, distance between center of first cabinet and venue reference point 0 along Y axis;



## Height, z-pos

when cluster flown, distance between top of first cabinet and venue geometry reference point 0 along Z axis;

when cluster stacked, distance between top of first cabinet and venue reference point 0 along Z axis;

**Horizontal angle** (Positive CCW looking from top) and **Vertical angle** (Positive going up) are for Cluster Orientation;

**Show Horizontal Coverage** displays -6dB lines for selected cluster in Venue tab; these line are defined as the intersection between each cabinet nominal -6dB coverage triangle and venue planes.

## Edit Venue

Opens the Edit Venue Planes Window:

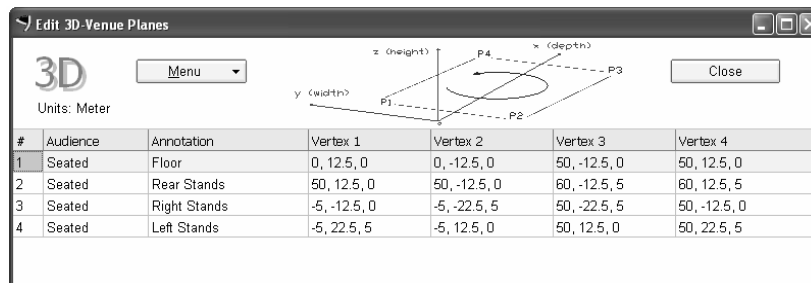

Please refer to Editing Venue section for features description.

## Spectrum (new)

Show / Hide Spectrum

Show Spectrum displays Frequency Response Plot next to Pressure Plot.

Hide Spectrum is identical to previous version display

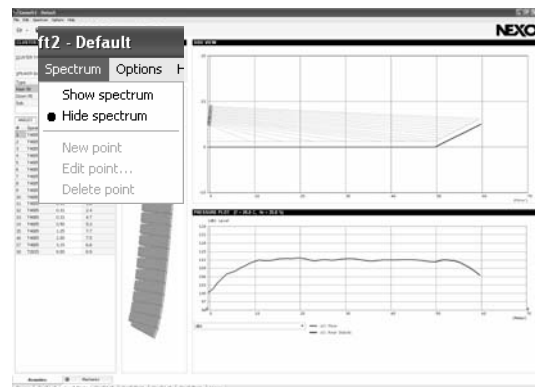
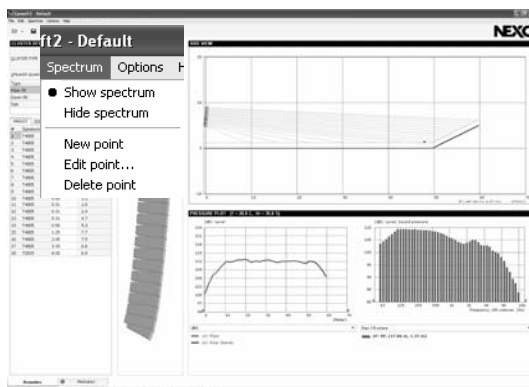



New Point

Opens Spectrum Point Coordinates Input Window

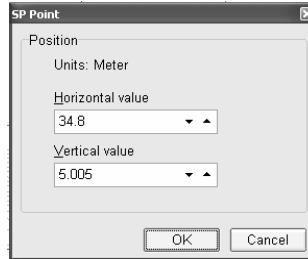

Edit Point

Opens Selected Spectrum Point Coordinates Input Window for editing

Delete Point

Deletes Selected Spectrum Point

### Options Menu

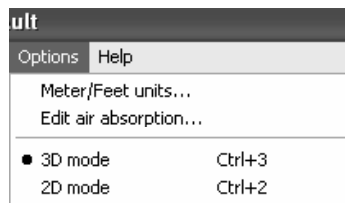

Meter / Feet Units

Opens the Units Window:

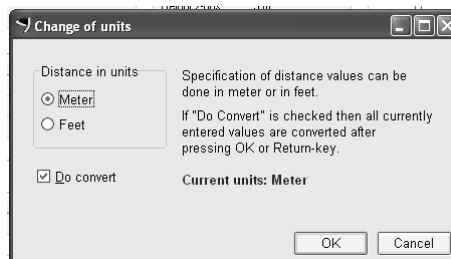

- Do Convert:
  - when selected, switching from Meter to Feet (or vice versa) will not change Venue dimensions
  - when unselected, switching from Meter to Feet (or vice versa) will not change numerical X/Y/Z values and will therefore scale up or down the venue.
- Meter: the project is defined in the metric (m) - kilogram (kg) units system;
- Feet: the project is defined in the feet (ft) - pound (Lb) units system;



Edit air absorption

Opens the Air absorption parameters Window

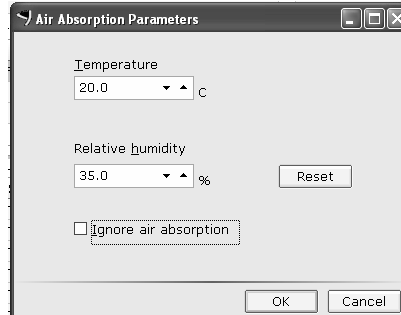

**Important :** please note that dBMIF curve remains unchanged with air absorption.

3D Mode / 2D Mode

Switches project from 2D to 3D Mode or opposite (see above). “2D” or “3D” are displayed next to toolbar as a reminder.

## Help Menu

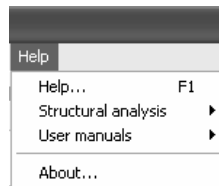

Help

Opens current GeoSoft Help Manual.

Structural Analysis

Opens NEXO Geo S8, Geo S12, Geo D or GeoT structural analysis PDF files.

User Manuals

Opens NEXO Geo S, Geo D or GEOT User Manual PDF files, with all setup instructions.

About Geosoft

Current GeoSoft Version.



**NEXO**

11/38

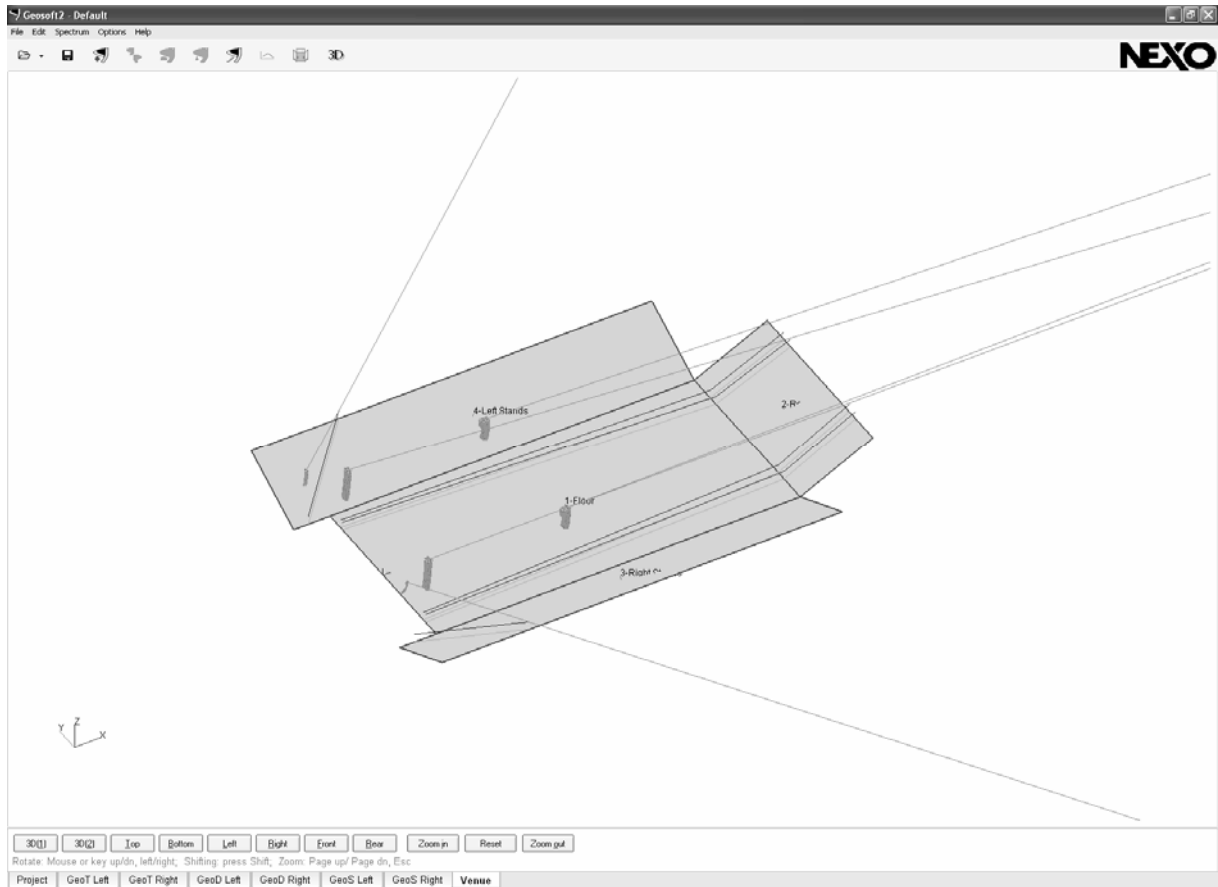

3D venue display

### Edit Venue Planes

Opens tables to edit planes as below

#	Audience	Annotation	Vertex 1	Vertex 2	Vertex 3	Vertex 4
2	Seated	Rear Stands	50, 12.5, 0	50, -12.5, 0	50, -12.5, 5	50, 12.5, 5
3	Seated	Right Stands	-5, -12.5, 0	-5, -22.5, 5	50, -22.5, 5	50, -12.5, 0
4	Seated	Left Stands	-5, 22.5, 5	-5, 12.5, 0	50, 12.5, 0	50, 22.5, 5
5	Seated					

#	Audience	Annotation	(X) Depth 1	(Z) Height 1	(X) Depth 2	(Z) Height 2
1	Seated	Floor	0	0	50	0
2	Seated	Rear Stands	50	0	60	5
3	Seated	Right Stands	-5	2.5	50	2.5
4	Seated	Left Stands	-5	2.5	50	2.5

Edit Venue Planes Table 3D and 2D



## Audience

*Seated* is 1.20 meter height mapping

*Standing* is 1.60 meter height mapping

*No audience* disables acoustic computations on selected plane, however, plane is still be displayed in Venue (typically, ceilings, walls).

*Disabled* disables both display and computations (this feature allows to enter various configurations in the same venue file)

## Annotation

Annotation is Plane name

Vertex 1 to 4

Vertex 1 to 4 are to enter 4 plane corners coordinates. When double-clicking on selected vertex, following Input Window appears:

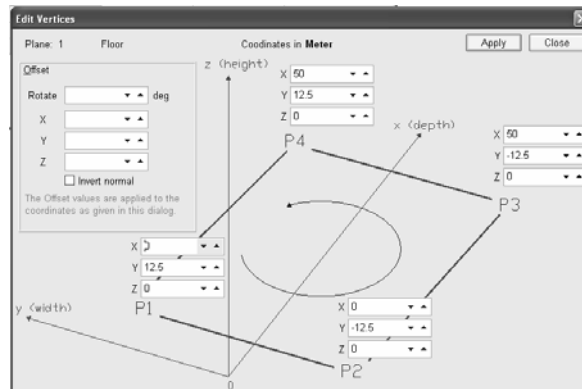

This window allows to enter X,Y and Z vertex coordinates, and to eventually rotate (around origin) or offset defined plane.

Values must be entered P1 to P4 going counter-clockwise.

***If vertexes are entered in the wrong order (ie clockwise), no values will be displayed in Cluster Pressure Plot. These planes can be easily inverted with the "Invert Plane" function.***

***Reversed planes can be easily identified as being white when seen from top (instead of grey).***

## Menu

*Menu* opens below selection (also available on right-mouse click on a plane)

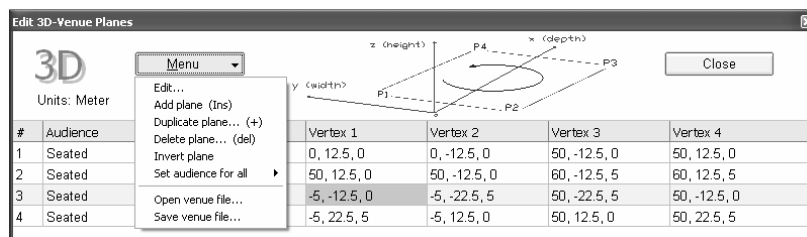

Edit Venue (3D Mode)

Opens Edit Vertices Window

NEXO

13/38



Add plane

Adds a new plane (with empty coordinates)

Duplicate plane

Opens below window, which allows rotating (around origin) or offsetting defined plane.

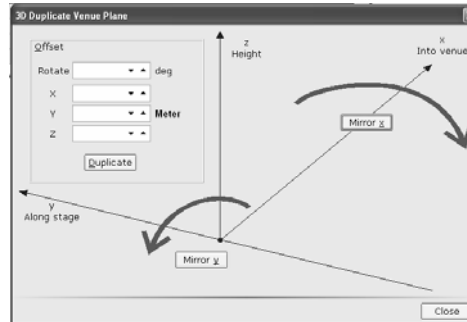

Delete Plane

Deletes selected plane

Invert Plane

Reverses P1 to P4 in P4 to P1 for proper plane orientation

Set Audience for all

No audience / Seated / Standing / Disabled defined simultaneously for all planes

Open Venue File

Opens .txt file (Geosoft2 Venue text format), .nxv file (Geosoft2 Nexo proprietary venue format) or .xar file (EASE 4™ Audience Export text format)

Importing Audience planes from Ease 4

To generate .xar files in Ease from the "Edit Project" page, select "File / Export Ascii File / Audience Areas". This will generate an .xar file, which Geosoft2 can import. Geosoft2 will automatically set the lower Z coordinates (height) to 0: cluster height might have to be adjusted accordingly, keeping in mind that Geosoft2 maps at 1.2m height (seated) or 1.6m height (standing).

**Important:** because Geosoft2 sets the lower plane at 0m height while importing from Ease .xar files, cluster rigging point z-coordinates might be different in Ease and Geosoft2. Double-check relative height from audience plane to cluster rigging point

Save Venue File

Saves .nxv file (Geosoft2 Nexo proprietary venue format)



### Edit Venue (2D Mode)

When selecting « 2D Mode » in the Option menu, planes are defined by two points (X, Z) coordinates.

#	Audience	Annotation	(X) Depth 1	(Z) Height 1	(X) Depth 2	(Z) Height 2
1	Seated	Floor	0	0	50	0
2	Seated	Rear Stands	50	0	60	5
3	Seated	Right Stands	-5	2.5	50	2.5
4	Seated	Left Stands	-5	2.5	50	2.5

Working in 2D mode is highly recommended for fast configuration definition since only 4 values are to be entered instead of 12 in 3D mode.

**Important:** when switching from 3D Mode to 2D Mode, all clusters horizontal angles as well as venue Y coordinates will be lost.



## PROJECT WINDOW

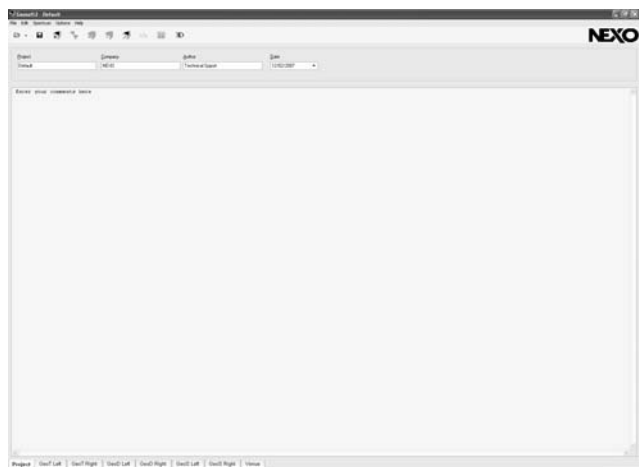

Project

Enter project name.

Company

Enter company name.

Author

Enter your name.

Date

Enter the date.

Text Window

Type your project comments here.



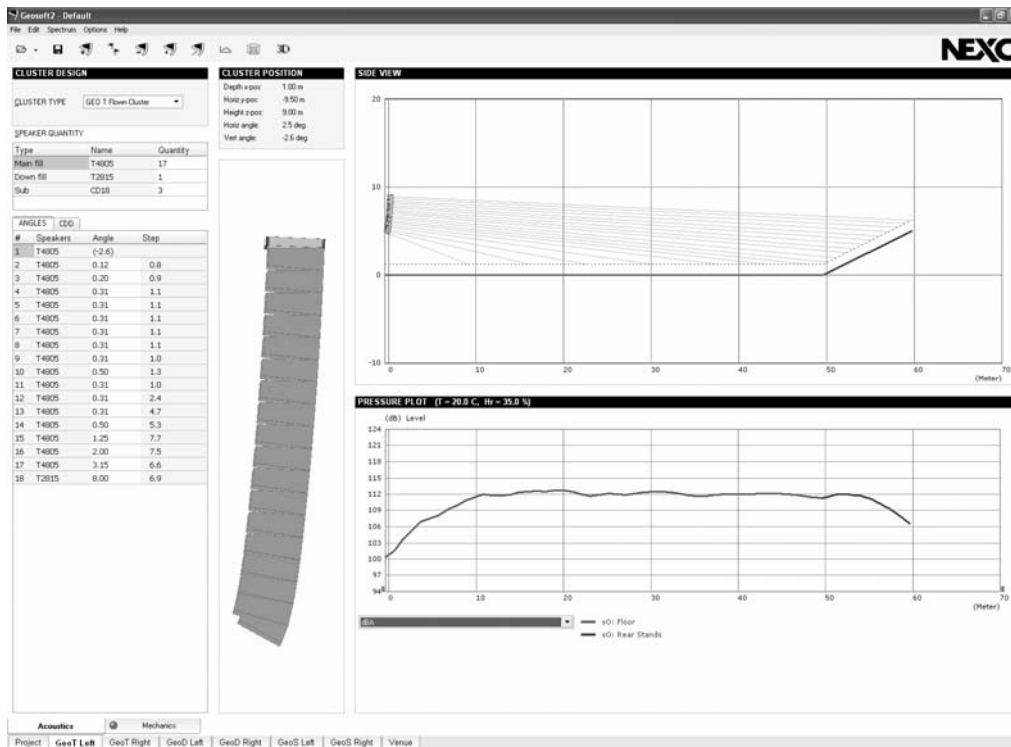

### Cluster Type

Flown / Stacked NEXO GEO S8, GEO S12, GEO D or GEO T clusters

### Speaker Quantity

Defines quantities for:

- NEXO GEO S805 / S830
- NEXO GEO S1210 / S1230
- NEXO GEO D10 / GEO SUB
- NEXO GEO T4805 / NEXO T2815 / CD18

### Insert / Remove

This feature is accessible by right-mouse clicking while in the Inter-Angle page, or by positioning cursor where a speaker needs to be inserted or removed and then changing the speaker quantity.

### Move Towards Bumper / Move Away Bumper

This feature is available on GeoS8, Geo S12 and GeoD, by right-mouse clicking in the Inter-Angle Page, or by clicking and dragging speaker #.

**IMPORTANT:** GeoS8, GeoS12 and GeoD mechanical computations are valid while positioning cabinet at any location in the cluster



## Rig Angles Tab

CLUSTER DESIGN		
CLUSTER TYPE: GEO T Flown Cluster		
SPEAKER QUANTITY		
Type	Name	Quantity
Main fill	T4805	17
Down fill	T2815	1
Sub	CD18	3

ANGLES	CDD		
#	Speakers	Angle	Step
1	T4805	(-2.6)	
2	T4805	0.12	0.8
3	T4805	0.20	0.9
4	T4805	0.31	1.1
5	T4805	0.31	1.1
6	T4805	0.31	1.1
7	T4805	0.31	1.1
8	T4805	0.31	1.1
9	T4805	0.31	1.0
10	T4805	0.50	1.3
11	T4805	0.31	1.0
12	T4805	0.31	2.4
13	T4805	0.31	4.7
14	T4805	0.50	5.3
15	T4805	1.25	7.7
16	T4805	2.00	7.5
17	T4805	3.15	6.6
18	T2815	8.00	6.9

ANGLES	CDD	
#	Speakers	Horiz coverage
1	T4805	90
2	T4805	90
3	T4805	90
4	T4805	90
5	T4805	90
6	T4805	90
7	T4805	90
8	T4805	90
9	T4805	90
10	T4805	90
11	T4805	90
12	T4805	90
13	T4805	90
14	T4805	90
15	T4805	90
16	T4805	90
17	T4805	90
18	T2815	120

Vertical Angle Configuration

Horizontal Dispersion Configuration

Choices between the cabinets are :

### GEO S8

- S805 to S805 : 0.31 - 0.50 - 0.80 – 1.25 – 2.00 – 3.15 – 5.00 degrees ;
- S805 to S830 : 17.5 degrees ;
- S830 to S830 : 17.5 -30 degrees ;

### GEO S12

- S1210 to S1210:  
0.20 - 0.31 - 0.50 - 0.80 – 1.25 – 2.00 – 3.15 – 5.00 – 6.25 – 8.00 – 10 degrees ;
- S1210 to S1230: 16 degrees;
- S1230 to S1230: (16) - 22.5 – 30 degrees;

*NB: 16° is allowed for specific installations where high dB SPL values are required. However, bandwidth is then limited to 10 kHz.*

### GEO D

- D10 to D10 (or D10 to GEO SUB or GEO SUB to GEO SUB)  
0.20 - 0.31 - 0.50 - 0.80 – 1.25 – 2.00 – 3.15 – 5.00 – 6.25 – 8.00 – 10 degrees ;

### GEO T

- T4805 to T4805 : 0.12 – 0.20 - 0.31 - 0.50 - 0.80 – 1.25 – 2.00 – 3.15 – 5.00 degrees ;
- T4805 to T2815 : 6.30 - 8.00 – 10.00 degrees ;
- T2815 to T2815 : 6.30 - 8.00 – 10.0 - 12.5 – 15.0 degrees.

Step

Non editable field ; gives the distance between adjacent cabinets targeted points on the audience.

NEXO

18/38



## CDD

Allows to define horizontal coverage for each cabinet (GeoS8, Geo S12 and Geo D)

## Cluster Position

CLUSTER POSITION	
Depth x-pos:	1.00 m
Horiz y-pos:	-9.50 m
Height z-pos:	9.00 m
Horiz angle:	2.5 deg
Vert angle:	-2.6 deg

Mouse Click inside the frame opens the Cluster Position Window (see above)

## Pressure Plot and Frequency Response display

### Pressure plot

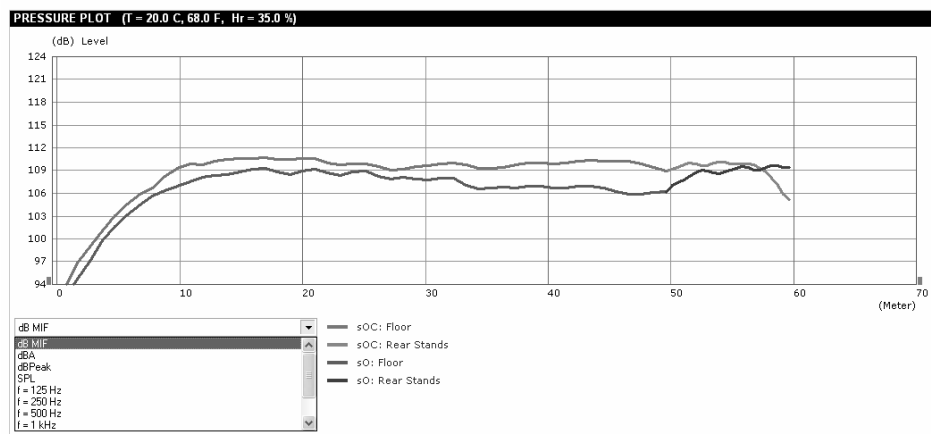

Displayed Pressure Levels curves are selectable and are :

- dB MIF, stands for dB "Make It Flat" ; for proper array curvature definition, this curve has to fit within 3 dB on the audience area. Please note that Air Absorption has no effect on dB MIF curve
- dBPeak, computed from 300 Hz to 3000 Hz with a 6 dB Peak Factor ;
- dBA, computed from 63 Hz to 16 kHz A-weighted ;
- dB SPL, summed from 63 Hz to 16 kHz, no weighting;
- dB SPL for each octave bands from 125 Hz to 8 kHz (63 Hz display is available for GeoSub)

Plots can be stored in memory by double-clicking on the audience name below display scrolling menu.

Plots in memory can be erased by selecting audience name below display scrolling menu, and pressing the "suppress" key.

## Frequency Response

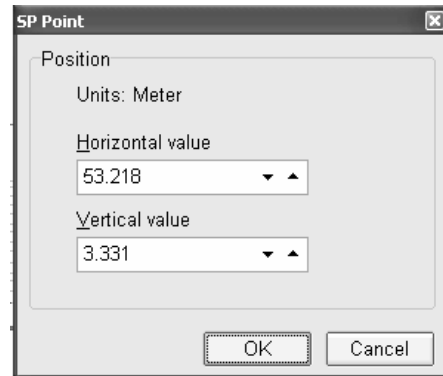
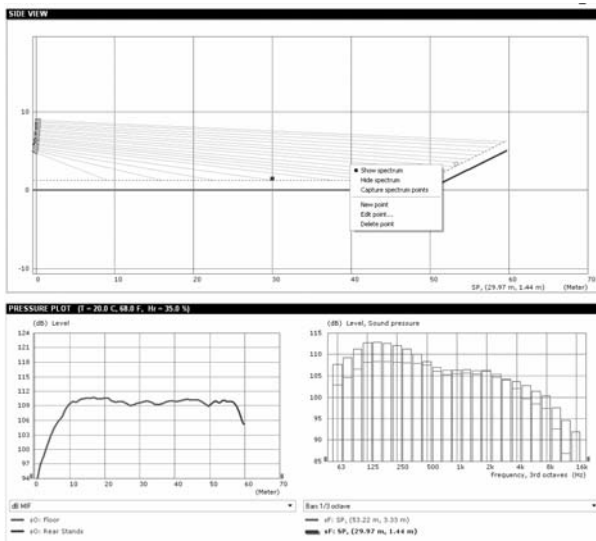

Frequency plot becomes available by selecting “Show Spectrum” in the Spectrum Menu (or Right Mouse Click on Side View).

Points for which frequency response will be computed are defined by Right Mouse clicking on Side View. SP Point window allows then to enter coordinates.

Curves can be displayed Continuous, Octave Bands, 1/3rd Octave Bands or 1/6th Octave Bands.

Plots can be stored in memory by double-clicking on the point coordinates below display scrolling menu.

Plots in memory can be erased by selecting point coordinates below display scrolling menu, and pressing the “suppress” key.

Plot Colors can be changed by clicking and dragging point coordinates below display; below figure is then displayed:

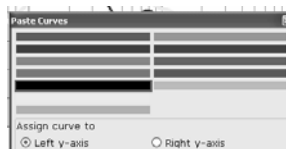

## Simulation conditions

- test signal : IEC268 filtered Pink Noise (similar spectral content than music);
- free-field ;

### **Important :**

- *for distances superior to 80 meters (~260 feet), temperature, wind and hygrometry gradients do not allow to make any reliable acoustic prediction.*
- *GeoSoft simulation does not take in to account any room contribution (floor reflection, reverberation...), nor another cluster contribution. Consequently, all dB values are default values that might increase from 3 to 6dB.*



## GEO S8 CLUSTER MECHANICAL WINDOW

### Configuration Settings

SETTINGS	
Rigging mode	CD12 link bar
Wind Beaufort 8	From rear
Cluster secured	No

#### Rigging Mode

##### NEXO GEO S8:

- Bumper Only (GeoS8 without CD12)
- Extension Bar at the back (GeoS8 without CD12)
- Extension Bar at the Front (GeoS8 without CD12)
- CD12 Link Bar (GeoS8 with CD12 Only)

#### Wind Beaufort 8

Corresponds to a 20.7 m/s wind. Options are:

- No Wind
- Wind from the back of the cluster
- Wind from the front of the cluster

Lateral wind is considered to have no influence on investigated forces.

#### Cluster Secured

Windforce distribution on cluster depends on how it is secured. Investigated cases are:

- No (cluster can rotate freely)
- Bottom: cluster secured at the bottom to avoid vertical rotation
- Top: top bumper rigidly secured to avoid vertical rotation (bottom unsecured)



## Cluster Dimensions and Weight

CLUSTER	
Cluster type	GEO 8 Flown Cluster
S805 (Array) Qty	7
S830 (Array) Qty	1
CD12 (Sub) Qty	2
Bumper angle	-11.00 deg
Lower cabinet angle	-38.19 deg
Cluster height (H)	2.00 m
Cluster width (W)	0.60 m
Cluster depth (D)	1.50 m
Rear rigging point height	9.09 m
Front rigging point height	9.13 m
Lower cabinet height	7.09 m
Distance between rigging points (A)	1.35 m
Gravity center to front rigging point (A2)	0.54 m
Gravity center to rear rigging point (A1)	0.82 m
Clearance from front rigging point (C2)	0.10 m
Clearance from rear rigging point (C1)	0.10 m
Cluster weight (M)	209.00 kg
Weight on front rigging point (M2)	126.36 kg
Weight on rear rigging point (M1)	82.64 kg

- Cluster Type : as in Acoustic Page
- GEO Quantity: as in Acoustic Page
- CD12 Quantity: as in Acoustic Page
- Bumper Angle: Angle in relation to Horizontal Line, CCW.
- Lower Cabinet Angle;
- Cluster Height: Overall Height including rigging accessories;
- Cluster Width: Overall Width including rigging accessories;
- Cluster Depth: Overall Depth including rigging accessories;
- Rear Rigging Point Height: Front Bumper Rigging Point height referenced to Z=0;
- Front Rigging Point Height: Rear Bumper Rigging Point height referenced to Z=0;
- Lower Cabinet Height: referenced to Z=0;
- Distance between rigging points: horizontal distance from Rear to Front Bumper Rigging Points
- Gravity Center to Front Rigging Point: horizontal distance from Gravity Center to Front Rigging Point (must be positive and less than distance between rigging points, turns red if gravity center off rigging points, turns orange if 5% to the limits)
- Gravity Center to Rear Rigging Point: horizontal distance from Gravity Center to Rear Rigging Point (must be positive and less than distance between rigging points, turns red if gravity center off rigging points, turns orange if 5% to the limits)
- Clearance from Front Rigging Point: minimum free space required ahead of Front Rigging Point
- Clearance from Rear Rigging Point: minimum free space required behind Rear Rigging Point
- Cluster Weight: total cluster weight including rigging accessories
- Weight on Front Rigging Point: must be positive and less than total Cluster Weight (turns red if gravity center off rigging points, turns orange if 5% to the limits)
- Weight on Rear Rigging Point: must be positive and less than total Cluster Weight (turns red if gravity center off rigging points, turns orange if 5% to the limits)



## Mechanical Forces

FORCES	
Allowed loads on bumper rear points S1	-13.70 kN / 9.00 kN
Applied loads on bumper rear points S1	1.65 kN
Allowed loads on bumper front points S2	-13.70 kN / 7.10 kN
Applied loads on bumper front points S2	-0.84 kN
Allowed moment on extension bar	2.40 kNm
Applied moment on extension bar (M0)	0.53 kNm
Allowed moment on link bar	2.40 kNm
Applied moment on link bar (M0)	0.53 kNm
Allowed load on CD12 flying rails	1.90 kN
Applied load on CD12 flying rails (FS3)	0.36 kN
Applied wind force on cluster (Fw)	0.25 kN

- Allowed Loads on Bumper Rear Points S1: theoretical pressure/tensile force values confirmed with destruction tests
- Applied Loads on Bumper Rear Points S1: configuration applied value (turns red if outside limits)
- Allowed Loads on Bumper Front Points S2: theoretical pressure/tensile values confirmed with destruction tests
- Applied Loads on Bumper Front Points S2: configuration applied value (turns red if outside limits)
- Allowed Moment on Extension Bar (closed cross-section): theoretical maximum moment force before bending, confirmed with destruction tests
- Applied Moment on Extension Bar (closed cross-section): configuration applied value (turns red outside above limits)
- Allowed Moment on Link Bar: theoretical maximum moment force before bending, confirmed with destruction tests
- Applied Moment on Link Bar: configuration applied value (turns red if outside limits)
- Allowed Load on CD12 flying rails: theoretical tensile force values
- Applied Load on CD12 flying rails: configuration applied values (turns red if outside limits)
- Wind force applied on cluster:
  - Rear or Front force applied when wind is present (Beaufort Scale = 8)
- Wind Offset Angle: Vertical Cluster rotation related to wind forces

## Angle Sequence

- Delta: Inter Cabinets Angle Sequence
- Sum: Cumulative Angle Sequence (which takes wind effect into account)

ANGLE SEQUENCE		
#	Delta	Sum
Bumper	-11.00	0.76
1	2.00	-1.24
2	3.15	-4.39
3	3.15	-7.54
4	3.15	-10.69
5	5.00	-15.69
6	5.00	-20.69
7	17.50	-38.19



## Working Load – Safety Factor – Lifting Factor

<b>WORKING LOAD - SAFETY FACTOR</b>	
% allowed working load (safety factor 1.5)	22
Safety factor for 100% allowed working load	6.8
Lifting factor	1.0

### Percentage of Allowed Working Load

Is based on the ratio of all applied moments and forces to their limit

Is determined by the component which is the closest to its limits

Corresponds to a Safety Factor of 1.5 when is equal to 100%

Must not be above 100% (turns red if so)

### Safety Factor for 100% of Allowed Working Load

Cluster configuration Safety Factor

Must not be below 1.5 (turns red if so)

Can be used to comply with local regulations

### Lifting Factor

Is 1.2 if no wind (where setup typically occurs)

Is 1 if wind (where setup is forbidden)

## Caution – Warning Messages

Warning Messages for Rigging feasibility and safety.

Permanently displayed messages

**CAUTION**  
READ USER MANUAL PRIOR TO OPERATION  
CHECK LOCAL REGULATIONS ON LOUDSPEAKER RIGGING SYSTEM  
ENSURE ANGLES SETTINGS ARE IDENTICALLY ON BOTH SIDES  
CHECK WITHOUT WINDFORCES

Conditional messages

These messages are related to unfeasible or unsafe loads:

FRONT RIGGING POINT NOT IN TENSION LOAD  
UNSAFE LOADING  
UNSAFE LOAD FOR LINK BAR  
UNSAFE LOAD FOR GEO S BUMPER  
SAFETY FACTOR TOO LOW



## Cluster Drawings

Drawings are displayed to show computed points and cluster setup configurations.

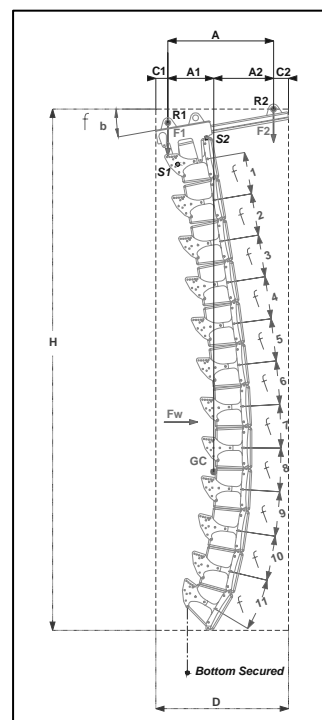
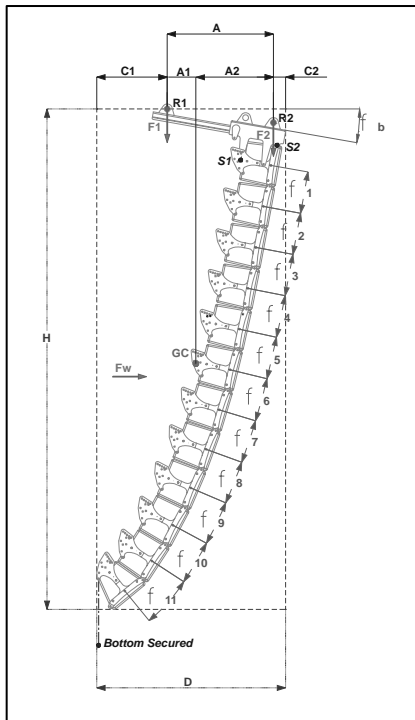
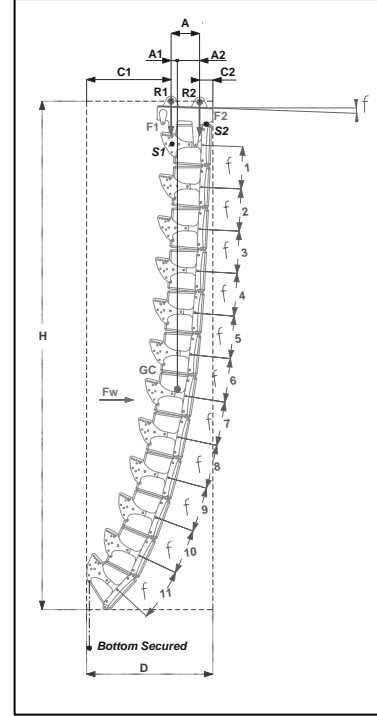
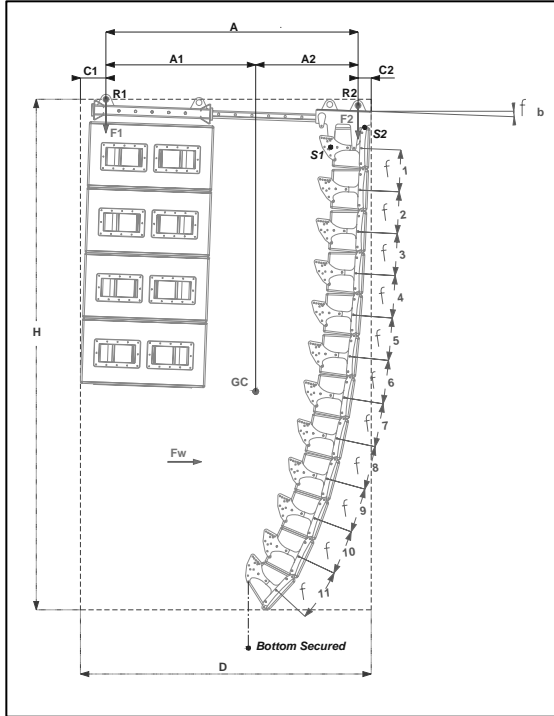



## GEO S12 CLUSTER MECHANICAL WINDOW

### Configuration Settings

SETTINGS	
Rigging mode	Single motor
Rigging point position	# -6
Actual bumper angle	-4.66 deg
Bumper angle error	0.34 deg
Wind Beaufort 8	No wind
Cluster secured	No

*Single Motor / One Rigging Point*

SETTINGS	
Rigging mode	Two motors
Rear rigging point	# -17
Front rigging point	# 17
Wind Beaufort 8	No wind
Cluster secured	No

*Two Motors / Two Rigging Points*

#### Rigging Mode

##### NEXO GEO S12:

- One motor or
- Two motors

#### Rigging point position

- When using one motor, gives the bumper hole position to achieve required bumper angle (turns red if gravity center is off hole range, turns orange when 5% to the limit).

#### Rear rigging point

- When using two motors, gives the bumper rear hole position (must be #-17)

#### Front rigging point

- When using two motors, gives the bumper front hole position (must be #17)

#### Wind Beaufort 8

- Not implemented at this time.

#### Cluster Secured

- Not implemented at this time



## Cluster Dimensions and Weight

CLUSTER	
Cluster type	GEO S12 Flown Cluste
S1210 (Array) Qty	7
S1230 (Array) Qty	1
Bumper angle	-5.40 deg
Lower cabinet angle	-29.91 deg
Cluster height (H)	2.89 m
Cluster width (W)	0.80 m
Cluster depth (D)	1.02 m
Rigging point height	6.14 m
Lower cabinet height	3.31 m
Front clearance from rigging point (C2)	0.03 m
Rear clearance from rigging point (C1)	0.39 m
Cluster weight (M)	279.37 kg

### Single Motor / One Rigging Point

- Cluster Type : as in Acoustic Page
- GEO S1210 Quantity: as in Acoustic Page
- GEO S1230 Quantity: as in Acoustic Page
- Bumper Angle: Angle in relation to Horizontal Line, CCW.
- Lower Cabinet Angle: bottom cabinet axis angle
- Cluster Height: Overall Height including rigging accessories;
- Cluster Width: Overall Width including rigging accessories;
- Cluster Depth: Overall Depth including rigging accessories;
- Rigging Point Height: Bumper Single Rigging Point height referenced to Z=0;
- Rear Rigging Point Height: Bumper Rigging Point #17 height referenced to Z=0;
- Front Rigging Point Height: Bumper Rigging Point #17 height referenced to Z=0;
- Lower Cabinet Height: referenced to Z=0;
- Distance between rigging points: horizontal distance from Rear to Front Bumper Rigging Points
- Gravity Center to Front (Rear) Rigging Point: horizontal distance from Gravity Center to Front (Rear) Rigging Point (must be positive and less than distance between rigging points, turns red if gravity center off rigging points, turns orange if 5% to the limits)
- Front (Rear) Clearance from Rigging Point: minimum free space required ahead of (behind) single rigging point;
- Clearance from Front (Rear) Rigging Point: minimum free space required ahead of Front (behind Rear ) Rigging Point
- Clearance from Rear Rigging Point: minimum free space required behind Rear Rigging Point
- Cluster Weight: total cluster weight including rigging accessories
- Weight on Front and Rear Rigging Point: must be positive and less than total Cluster Weight (turns red if gravity center off rigging points, turns orange if 5% to the limits)

CLUSTER	
Cluster type	GEO S12 Flown Cluste
S1210 (Array) Qty	7
S1230 (Array) Qty	1
Bumper angle	-5.40 deg
Lower cabinet angle	-29.91 deg
Cluster height (H)	2.89 m
Cluster width (W)	0.80 m
Cluster depth (D)	1.02 m
Rear rigging point height	6.15 m
Front rigging point height	6.10 m
Lower cabinet height	3.31 m
Distance between rigging points (A)	0.59 m
Gravity center to front rigging point (A2)	0.42 m
Gravity center to rear rigging point (A1)	0.18 m
Clearance from front rigging point (C2)	0.03 m
Clearance from rear rigging point (C1)	0.39 m
Cluster weight (M)	279.37 kg
Weight on front rigging point (M2)	83.00 kg
Weight on rear rigging point (M1)	196.37 kg

### Two Motors / Two Rigging Points



### Mechanical Forces

Not implemented at this time

### Angle Sequence

- Delta: Inter Cabinets Angle Sequence
- Sum: Cumulative Angle Sequence (which takes wind effect into account)

<b>ANGLE SEQUENCE</b>		
#	Delta	Sum
Bumper	-11.00	0.76
1	2.00	-1.24
2	3.15	-4.39
3	3.15	-7.54
4	3.15	-10.69
5	5.00	-15.69
6	5.00	-20.69
7	17.50	-38.19

### Working Load – Safety Factor – Lifting Factor

Not implemented at this time

### Caution – Warning Messages

Warning Messages for Rigging feasibility and safety.

Permanently displayed messages

**CAUTION**  
**READ USER MANUAL PRIOR TO OPERATION**  
**CHECK LOCAL REGULATIONS ON LOUDSPEAKER RIGGING SYSTEM**  
**ENSURE ANGLES SETTINGS ARE IDENTICALLY ON BOTH SIDES**

Conditional messages

These messages are related to unfeasible loads:

**GRAVITY CENTER OFF THE BUMPER**  
**ANGLE OUT OF RANGE**

Please note that safety warnings are not implemented at this time.

## Cluster Drawings

Drawings are displayed to show computed points and cluster setup configurations.

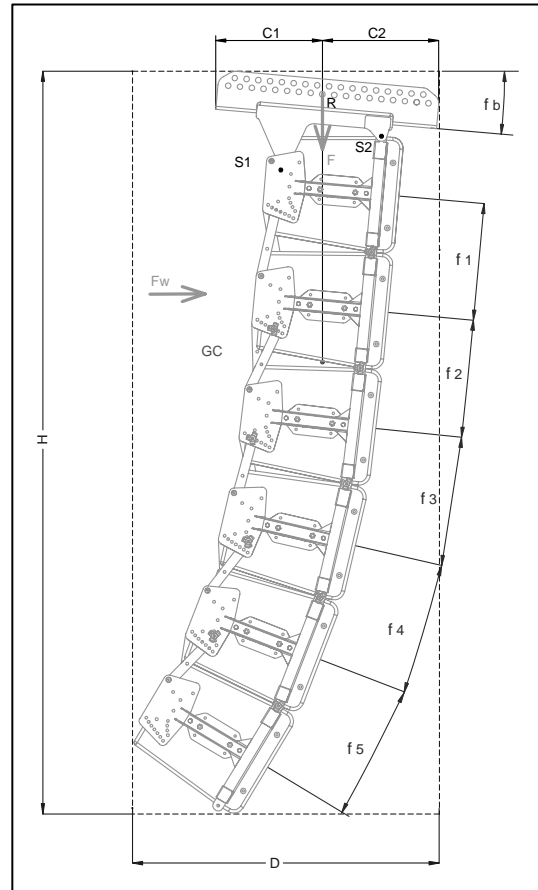
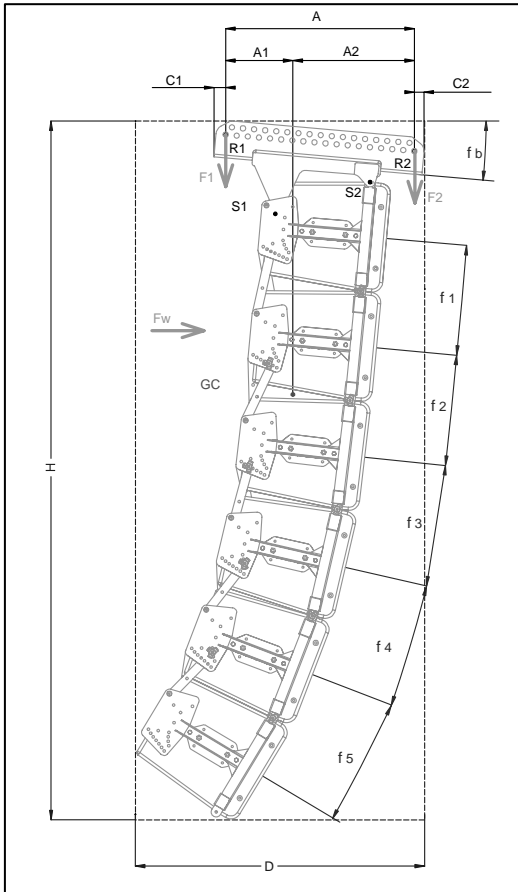



## GEO D CLUSTER MECHANICAL WINDOW

### Configuration Settings

SETTINGS	
Rigging top	Bumper + ExBar1
Rigging bottom	Bottom-Bumper
Chain lever hoist	Leva750
Wind Beaufort 8	No wind
Cluster secured	No

Rigging top (case dependent, selectable)

1 Motor + EXBar1: GEO Bridle + GEOD bumper + Short Extension Bar + Wheel (only for GEO D clusters)

2 Motors + EXBar1: GEOD bumper + Short Extension Bar (only for GEO D clusters)

2 Motors + EXBar2: GEOD bumper + Long Extension Bar (for GEO D and GEO SUB clusters)

Rigging bottom (case dependent, automatic)

Bottom-Bumper: GEOD bottom bumper (only for GEO D or combined GEO D / GEO SUB clusters)

Bumper + ExBar3: GEO SUB bottom bumper (only for GEO SUB clusters)

Chain lever hoist (selectable)

Leva 750: for up to 7.5 kN compression force

Leva 1500: from 7.5 kN to 15 kN compression force

*NB: when 1 motor, LEVA750 is mandatory*

Wind Beaufort 8

Corresponds to a 20.7 m/s wind. Options are:

- No Wind
- Wind from the back of the cluster
- Wind from the front of the cluster

Lateral wind is considered to have no influence on investigated forces.

Cluster Secured

Windforce distribution on cluster depends on how it is secured. Investigated cases are:

- No (cluster can rotate freely)
- Bottom: cluster secured at the bottom to avoid vertical rotation

*NB: when 1 motor, securing bottom cluster is mandatory*



## Cluster Dimensions and Weight (2 rigging points)

CLUSTER	
Cluster type	GEO D Flown Cluster
Geo Sub (Array) Qty	4
D-10 (Array) Qty	12
Bumper angle	0.50 deg
Lower cabinet angle	-5.93 deg
Cluster height (H)	6.60 m
Cluster width (W)	0.74 m
Cluster depth (D)	1.46 m
Rear rigging point height	9.10 m
Front rigging point height	9.11 m
Lower cabinet height	2.64 m
Distance between rigging points (A)	1.08 m
Gravity center to front rigging point (A2)	0.25 m
Gravity center to rear rigging point (A1)	0.83 m
Clearance from front rigging point (C2)	0.19 m
Clearance from rear rigging point (C1)	0.18 m
Cluster weight (M)	1106.40 kg
Weight on front rigging point (M2)	852.10 kg
Weight on rear rigging point (M1)	254.30 kg

- Cluster Type : as in Acoustic Page
- GEO SUB: as in Acoustic Page
- GEO D10: as in Acoustic Page
- Bumper Angle: Angle in relation to Horizontal Line, CCW.
- Lower Cabinet Angle;
- Cluster Height: Overall Height including rigging accessories;
- Cluster Width: Overall Width including rigging accessories;
- Cluster Depth: Overall Depth including rigging accessories;
- Rear Rigging Point Height: Rear Bumper Rigging Point height referenced to Z=0;
- Front Rigging Point Height: Front Bumper Rigging Point height referenced to Z=0;
- Lower Cabinet Height: referenced to Z=0;
- Distance between rigging points: horizontal distance from Rear to Front Bumper Rigging Points
- Gravity Center to Front Rigging Point: horizontal distance from Gravity Center to Front Rigging Point (must be positive and less than distance between rigging points, turns red if gravity center off rigging points, turns orange if 5% to the limits)
- Gravity Center to Rear Rigging Point: horizontal distance from Gravity Center to Rear Rigging Point (must be positive and less than distance between rigging points, turns red if gravity center off rigging points, turns orange if 5% to the limits)
- Clearance from Front Rigging Point: minimum free space required ahead of Front Rigging Point
- Clearance from Rear Rigging Point: minimum free space required behind Rear Rigging Point
- Cluster Weight: total cluster weight including rigging accessories
- Weight on Front Rigging Point: must be positive and less than total Cluster Weight (turns red if gravity center off rigging points, turns orange if 5% to the limits)
- Weight on Rear Rigging Point: must be positive and less than total Cluster Weight (turns red if gravity center off rigging points, turns orange if 5% to the limits)



## Mechanical Forces

<b>FORCES</b>	
Allowed force on bumper front rigging point R2	23.60 kN
Applied force on bumper front rigging point R2	8.52 kN
Allowed force on bumper rear rigging point R1	23.60 kN
Applied force on bumper rear rigging point R1	2.54 kN
Allowed force on bumper front connecting point S2	-5.00 kN / 15.00 kN
Applied force on bumper front connecting point S2	3.81 kN
Allowed force on bumper rear connecting point S1	-5.00 kN / 15.00 kN
Applied force on bumper rear connecting point S1	0.00 kN
Allowed force on cabinet front connecting point S2	-15.00 kN / 15.00 kN
Applied force on cabinet front connecting point S2	0.44 kN / 3.55 kN
Allowed force on cabinet rear connecting point S1	-15.00 kN / 15.00 kN
Applied force on cabinet rear connecting point S1	-1.41 kN / -0.17 kN
Allowed perpendicular force on reinforcement bar	3.55 kN
Applied perpendicular force on reinforcement bar	0.22 kN
Allowed force on Kelping chain	7.50 kN
Applied force on Kelping chain	2.75 kN
Allowed force on cabinet connection to bottom bumper	15.00 kN
Applied force on cabinet connection to bottom bumper	2.74 kN

- Allowed force on bumper front rigging point R2: theoretical tensile force value limit
- Applied force on bumper front rigging point R2: applied value (turns red if outside limits)
- Allowed force on bumper rear rigging point R1: theoretical tensile force value limit
- Applied force on bumper rear point rigging R1: applied value (turns red if outside limits)
- Allowed force on bumper front connecting point to top cabinet S2: theoretical pressure/tensile force value limit
- Applied force on bumper front connecting point to top cabinet S2: applied value (turns red if outside limits)
- Allowed force on bumper rear connecting point to top cabinet S1: theoretical pressure/tensile force value limit
- Applied force on bumper rear connecting point to top cabinet S1: applied value (turns red if outside limits)
- Allowed force on front connecting point S2: theoretical pressure/tensile force value limit
- Applied force on front connecting point S2: applied value (turns red if outside limits)
- Allowed force on rear connecting point S1: theoretical pressure/tensile force value limit
- Applied force on rear connecting point S1: applied value (turns red if outside limits)
- Allowed perpendicular force on reinforcement bar: theoretical pressure/tensile limits for side metal parts
- Applied perpendicular force on reinforcement bar: applied value (turns red if outside limits)
- Allowed force on Kelping Chain: compression force theoretical limit
- Applied force on Kelping Chain: applied value (turns red if outside limits)
- Allowed force on cabinet connection to bottom cabinet: theoretical limit
- Applied force on cabinet connection to bottom cabinet: applied value (turns red if outside limits)





## Cluster Dimensions and Weight (1 rigging point)

CLUSTER	
Cluster type	GEO D Flown Cluster
Geo Sub (Array) Qty	0
D-10 (Array) Qty	6
Bumper angle	-1.00 deg
Lower cabinet angle	-23.55 deg
Bridle front leg to bumper angle	73.43 deg
Bridle rear leg to bumper angle	64.18 deg
Bridle front leg to rear leg angle	42.39 deg
Cluster height (H)	2.45 m
Cluster width (W)	0.74 m
Cluster depth (D)	1.03 m
Rigging point height	9.96 m
Lower cabinet height	6.82 m
Front clearance from rigging point (C2)	0.45 m
Rear clearance from rigging point (C1)	0.67 m
Cluster weight (M)	412.40 kg

- Cluster Type : as in Acoustic Page
- GEO D10: as in Acoustic Page
- Bumper Angle: Angle in relation to Horizontal Line, CCW.
- Lower Cabinet Angle;
- Bridle Front leg to bumper angle: enclosed angle between the two
- Bridle Rear leg to bumper angle: enclosed angle between the two
- Bridle front leg to rear leg angle: enclosed angle between the two
- Cluster Height: Overall Height including rigging accessories;
- Cluster Width: Overall Width including rigging accessories;
- Cluster Depth: Overall Depth including rigging accessories;
- Rigging Point Height: Bridle rigging point height;
- Lower Cabinet Height: referenced to Z=0;
- Clearance from Front Rigging Point: minimum free space required ahead of Front Rigging Point
- Clearance from Rear Rigging Point: minimum free space required behind Rear Rigging Point
- Cluster Weight: total cluster weight including rigging accessories



## Mechanical Forces

<b>FORCES</b>	
Allowed force on bumper front rigging point R2	23.60 kN
Applied force on bumper front rigging point R2	8.52 kN
Allowed force on bumper rear rigging point R1	23.60 kN
Applied force on bumper rear rigging point R1	2.54 kN
Allowed force on bumper front connecting point S2	-5.00 kN / 15.00 kN
Applied force on bumper front connecting point S2	3.81 kN
Allowed force on bumper rear connecting point S1	-5.00 kN / 15.00 kN
Applied force on bumper rear connecting point S1	0.00 kN
Allowed force on cabinet front connecting point S2	-15.00 kN / 15.00 kN
Applied force on cabinet front connecting point S2	0.44 kN / 3.55 kN
Allowed force on cabinet rear connecting point S1	-15.00 kN / 15.00 kN
Applied force on cabinet rear connecting point S1	-1.41 kN / -0.17 kN
Allowed perpendicular force on reinforcement bar	3.55 kN
Applied perpendicular force on reinforcement bar	0.22 kN
Allowed force on Kelping chain	7.50 kN
Applied force on Kelping chain	2.75 kN
Allowed force on cabinet connection to bottom bumper	15.00 kN
Applied force on cabinet connection to bottom bumper	2.74 kN

- Allowed force on bumper front rigging point R2: theoretical tensile force value limit
- Applied force on bumper front rigging point R2: applied value (turns red if outside limits)
- Allowed force on bumper rear rigging point R1: theoretical tensile force value limit
- Applied force on bumper rear point rigging R1: applied value (turns red if outside limits)
- Allowed force on bumper front connecting point to top cabinet S2: theoretical pressure/tensile force value limit
- Applied force on bumper front connecting point to top cabinet S2: applied value (turns red if outside limits)
- Allowed force on bumper rear connecting point to top cabinet S1: theoretical pressure/tensile force value limit
- Applied force on bumper rear connecting point to top cabinet S1: applied value (turns red if outside limits)
- Allowed force on front connecting point S2: theoretical pressure/tensile force value limit
- Applied force on front connecting point S2: applied value (turns red if outside limits)
- Allowed force on rear connecting point S1: theoretical pressure/tensile force value limit
- Applied force on rear connecting point S1: applied value (turns red if outside limits)
- Allowed perpendicular force on reinforcement bar: theoretical pressure/tensile limits for side metal parts
- Applied perpendicular force on reinforcement bar: applied value (turns red if outside limits)
- Allowed force on Kelping Chain: compression force theoretical limit
- Applied force on Kelping Chain: applied value (turns red if outside limits)
- Allowed force on cabinet connection to bottom cabinet: theoretical limit
- Applied force on cabinet connection to bottom cabinet: applied value (turns red if outside limits)



### Angle Sequence

- Delta: Inter Cabinets Angle Sequence
- Sum: Cumulative Angle Sequence

ANGLE SEQUENCE		
#	Delta	Sum
Bumper	0.50	0.50
1	0.20	0.30
2	0.20	0.10
3	0.20	-0.10
4	0.20	-0.30
5	0.32	-0.62
6	0.32	-0.93
7	0.32	-1.25
8	0.32	-1.56
9	0.32	-1.88
10	0.32	-2.19
11	0.32	-2.50
12	0.32	-2.82
13	0.32	-3.13
14	0.80	-3.94
15	2.00	-5.93

### Working Load – Safety Factor – Lifting Factor

WORKING LOAD - SAFETY FACTOR	
GEOD Cluster	
% allowed working load (safety factor 4)	37
Safety factor for 100% allowed working load	10.8

GeoD cluster - Percentage of Allowed Working Load

Is based on the ratio of all applied moments and forces to their limit

Is determined by the component which is the closest to its limits

Corresponds to a Safety Factor of 4 when is equal to 100%

Must not be above 100% (turns red if so)

GeoD cluster - Safety Factor for 100% of Allowed Working Load

Cluster configuration Safety Factor

Must not be below 4 (turns red if so)

Can be used to comply with local regulations



## Caution – Warning Messages

Warning Messages for Rigging feasibility and safety.

Permanently displayed messages

### **CAUTION**

**READ USER MANUAL PRIOR TO OPERATION**  
**CHECK LOCAL REGULATIONS ON LOUDSPEAKER RIGGING SYSTEM**  
**ENSURE ANGLES SETTINGS ARE IDENTICALLY ON BOTH SIDES**  
**CHECK WITHOUT WINDFORCES**

Conditional messages

These messages are related to unfeasible or unsafe loads:

**FRONT RIGGING POINT NOT IN TENSION LOAD**  
**UNSAFE LOAD FOR GEOT CLUSTER**  
**UNSAFE LOAD FOR CD18 CLUSTER**  
**SAFETY FACTOR TOO LOW**

Cluster Drawings

Drawings are displayed to show computed points and cluster setup configurations.

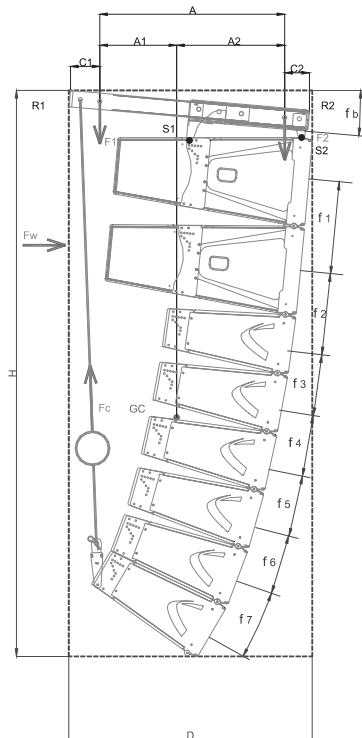

**NEXO**



## GEO T CLUSTER MECHANICAL WINDOW

### Configuration Settings

SETTINGS	
Rigging mode	Bumper only (tens
Wind Beaufort 8	No wind
Cluster secured	-

#### Rigging Mode

##### NEXO GEO T

- Bumper Only (Tension Mode)
- Bumper + Half Kelping Beam (Tension mode), which allows greater distance between rigging points
- Compression Mode + 20° Kelping Beam
- Compression Mode + Half Kelping Beam

#### Wind Beaufort 8

Corresponds to a 20.7 m/s wind. Options are:

- No Wind
- Wind from the back of the cluster
- Wind from the front of the cluster

Lateral wind is considered to have no influence on investigated forces.

#### Cluster Secured

It is assumed that wind cannot rotate cluster, and that therefore cluster does not need to be secured



## Cluster Dimensions and Weight

CLUSTER	
Cluster type	GEO T Flown Cluster
T4805 (Array) Qty	17
T2815 (Array) Qty	1
CD18 (Sub) Qty	2
Bumper angle	-2.60 deg
Lower cabinet angle	-21.16 deg
Cluster height (H)	4.69 m
Cluster width (W)	0.90 m
Cluster depth (D)	1.07 m
Rear rigging point height	9.26 m
Front rigging point height	9.24 m
Lower cabinet height	4.58 m
Distance between rigging points (A)	0.55 m
Gravity center to front rigging point (A2)	0.39 m
Gravity center to rear rigging point (A1)	0.16 m
Clearance from front rigging point (C2)	0.11 m
Clearance from rear rigging point (C1)	0.41 m
Cluster weight (M)	975.00 kg
Weight on front rigging point (M2)	278.46 kg
Weight on rear rigging point (M1)	696.54 kg

- Cluster Type : as in Acoustic Page
- GEO Quantity: as in Acoustic Page
- CD18 Quantity: as in Acoustic Page
- Bumper Angle: Angle in relation to Horizontal Line, CCW.
- Lower Cabinet Angle;
- Cluster Height: Overall Height including rigging accessories;
- Cluster Width: Overall Width including rigging accessories;
- Cluster Depth: Overall Depth including rigging accessories;
- Rear Rigging Point Height: Rear Bumper Rigging Point height referenced to Z=0;
- Front Rigging Point Height: Front Bumper Rigging Point height referenced to Z=0;
- Lower Cabinet Height: referenced to Z=0;
- Distance between rigging points: horizontal distance from Rear to Front Bumper Rigging Points
- Gravity Center to Front Rigging Point: horizontal distance from Gravity Center to Front Rigging Point (must be positive and less than distance between rigging points, turns red if gravity center off rigging points, turns orange if 5% to the limits)
- Gravity Center to Rear Rigging Point: horizontal distance from Gravity Center to Rear Rigging Point (must be positive and less than distance between rigging points, turns red if gravity center off rigging points, turns orange if 5% to the limits)
- Clearance from Front Rigging Point: minimum free space required ahead of Front Rigging Point
- Clearance from Rear Rigging Point: minimum free space required behind Rear Rigging Point
- Cluster Weight: total cluster weight including rigging accessories
- Weight on Front Rigging Point: must be positive and less than total Cluster Weight (turns red if gravity center off rigging points, turns orange if 5% to the limits)
- Weight on Rear Rigging Point: must be positive and less than total Cluster Weight (turns red if gravity center off rigging points, turns orange if 5% to the limits)



## Mechanical Forces

FORCES	
Allowed load on bumper configuration rear point S1	57.25 kN
Applied load on bumper configuration rear point S1	6.48 kN
Allowed load on bumper configuration front point S2	57.25 kN
Applied load on bumper configuration front point S2	2.82 kN
Allowed pressure/tensile loads on T4805 rear point S1	-36.00 kN / 26.00 kN
Applied min/max loads on T4805 rear point S1	0.00 kN / 4.93 kN
Allowed pressure/tensile loads on T4805 rear point S2	-36.00 kN / 34.50 kN
Applied min/max loads on T4805 rear point S2	-0.35 kN / 0.32 kN
Allowed pressure/tensile loads on T2815 rear point S1	0.00 kN / 14.75 kN
Applied min/max loads on T2805 rear point S1	0.00 kN / 0.08 kN
Allowed pressure/tensile loads on T2815 rear point S2	-36.00 kN / 34.50 kN
Applied min/max loads on T2805 rear point S2	0.00 kN / 0.08 kN
Allowed load on Kelping chain	15.00 kN
Applied load on Kelping chain	0.00 kN
Allowed load on CD18 flying rails	1.90 kN
Applied load on CD18 flying rails	0.80 kN

- Allowed load on selected bumper rear rigging point R1: theoretical tensile force value limit
- Applied load on selected bumper rear rigging point R1: configuration applied value (turns red if outside limits)
- Allowed load on selected bumper front rigging point R2: theoretical tensile force value limit
- Applied load on selected bumper front point rigging R2: configuration applied value (turns red if outside limits)
- Allowed pressure/tensile loads on T4805 rear point S1: theoretical pressure/tensile force value limit
- Applied min/max loads on T4805 rear point S1: configuration applied value (turns red if outside limits)
- Allowed pressure/tensile loads on T4805 front point S2: theoretical pressure/tensile force value limit
- Applied min/max loads on T4805 front point S2: configuration applied value (turns red if outside limits)
- Allowed pressure/tensile loads on T2815 rear point S1: theoretical pressure/tensile force value limit
- Applied min/max loads on T2815 rear point S1: configuration applied value (turns red if outside limits)
- Allowed pressure/tensile loads on T2815 front point S2: theoretical pressure/tensile force value limit
- Applied min/max loads on T2815 front point S2: configuration applied value (turns red if outside limits)
- Allowed load on Kelping Chain: theoretical tensile force value limit
- Applied load on Kelping Chain: configuration applied value (turns red if outside limits)
- Allowed Load on CD18 flying rails: theoretical tensile force values
- Applied Load on CD18 flying rails: configuration applied values (turns red if outside limits)



### Angle Sequence

- Delta: Inter Cabinets Angle Sequence
- Sum: Cumulative Angle Sequence

<b>ANGLE SEQUENCE</b>		
#	Delta	Sum
Bumper	-11.00	0.76
1	2.00	-1.24
2	3.15	-4.39
3	3.15	-7.54
4	3.15	-10.69
5	5.00	-15.69
6	5.00	-20.69
7	17.50	-38.19

### Working Load – Safety Factor – Lifting Factor

<b>WORKING LOAD - SAFETY FACTOR</b>	
<b>GEOT Cluster</b>	
% allowed working load (safety factor 4)	19
Safety factor for 100% allowed working load	21.1
<b>CD18 Cluster</b>	
% allowed working load (safety factor 4)	42
Safety factor for 100% allowed working load	9.5

#### GeoT cluster - Percentage of Allowed Working Load

- Is based on the ratio of all applied moments and forces to their limit
- Is determined by the component which is the closest to its limits
- Corresponds to a Safety Factor of 4 when is equal to 100%
- Must not be above 100% (turns red if so)

#### GeoT cluster - Safety Factor for 100% of Allowed Working Load

- Project configuration Safety Factor
- Must not be below 4 (turns red if so)
- Can be used to comply with local regulations

#### CD18 cluster - Percentage of Allowed Working Load

- Is based on the ratio of all applied moments and forces to their limit
- Is determined by the component which is the closest to its limits
- Corresponds to a Safety Factor of 4 when is equal to 100%
- Must not be above 100% (turns red if so)

#### CD18 cluster - Safety Factor for 100% of Allowed Working Load

- Project configuration Safety Factor
- Must not be below 4 (turns red if so)
- Can be used to comply with local regulations





## Caution – Warning Messages

Warning Messages for Rigging feasibility and safety.

Permanently displayed messages

### **CAUTION**

**READ USER MANUAL PRIOR TO OPERATION**  
**CHECK LOCAL REGULATIONS ON LOUDSPEAKER RIGGING SYSTEM**  
**ENSURE ANGLES SETTINGS ARE IDENTICALLY ON BOTH SIDES**  
**CHECK WITHOUT WINDFORCES**

Conditional messages

These messages are related to unfeasible or unsafe loads:

**FRONT RIGGING POINT NOT IN TENSION LOAD**  
**UNSAFE LOAD FOR GEOT CLUSTER**  
**UNSAFE LOAD FOR CD18 CLUSTER**  
**SAFETY FACTOR TOO LOW**

Cluster Drawings

Drawings are displayed to show computed points and cluster setup configurations.

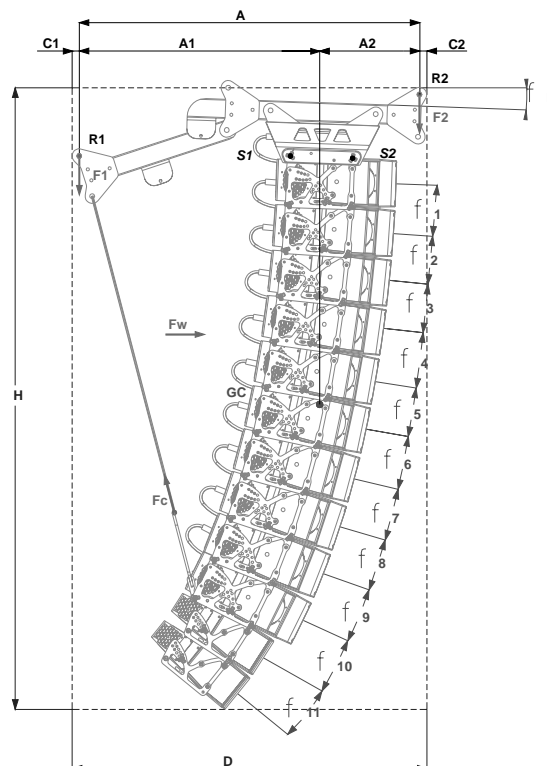

**NEXO**